

Programmable Delay Line DL1-544-1600ps

MTS-No.: 28150

Description

The DL1-544-1600ps from MTS Systemtechnik is designed for operations between 500 MHz and 4000 MHz. The delay of this unit is adjustable, continuously and without breaks from 0 to 1600 ps in 5 / 10 ps steps. The interchangeable in- and output ports are protected by internal blocking capacitors.

This delay line can be used very flexible because of its compact design and the controlling via TTL interface (8 bit parallel).



Technical data:

1 RF-specifications:

1.1 Impedance	50 Ω		
1.2 Input power			
- Absolute ¹	34 dBm max.		
- Operating: Pulsed ²	31 dBm max.		
- Operating: CW	28 dBm max.		
1.3 Voltage rating	50 WVDC		
1.4 Frequency range	500 - 4000 MHz		
1.5 Delay	0 - 640 ps in 5 ps steps		
	640 - 1600 ps in 10 ps steps		
	min.	typ.	max.
1.6 VSWR in / out		1.3	2.0
1.7 Insertion loss (IL)			
@ 0 ps			
@ 500 MHz		5.5 dB	6.0 dB
@ 4000 MHz		10.0 dB	12.0 dB
@ 1600 ps			
@ 500 MHz		5.7 dB	6.1 dB
@ 4000 MHz		14.0 dB	16.0 dB
1.8 IL derating / 20 MHz		0.04 dB	0.06 dB
1.9 Input IP3		75 dBm	
1.10 Switching speed		1 μs	
1.11 Delay accuracy			
@ 500 - 2000 MHz			
@ 0 - 600 ps		±2 ps	± 5 ps
@ 605 - 1200 ps		±4 ps	± 8 ps
@ 1210 - 1600 ps		±6 ps	±12 ps
@ 2000 - 4000 MHz			
@ 0 - 600 ps		±2 ps	± 5 ps
@ 605 - 1200 ps		±3 ps	± 6 ps
@ 1210 - 1600 ps		±5 ps	±10 ps

2 Connections:

2.1 RF connectors	SMA female
2.2 Control connector	12pole male, type SMC Erni

3 General specifications:

3.1 Internal voltage (TTL)	5 VDC ±5 %
3.2 Power consumption	10 mW max.
3.3 Control	8 bit parallel (TTL)
3.4 Operating temperature	-40 °C - +85 °C
3.5 Storage temperature	-55 °C - +150 °C
3.6 Reference temperature of specifications (typ.)	+25 °C
3.7 Dimensions (without connections)	85 mm x 80 mm x 12.4 mm (LxWxH)
3.8 Case style	Milled aluminium enclosure
3.9 Colour	SurTec650 (Chrome alloy)
3.10 Weight	190 grams

4 Delivered parts:

DL1-544-1600ps
 Datasheet
 Drawing and connector pin assignment

5 Comments:

Warranty 12 months
 RoHS-compliant Yes

6 Recommended accessories:

RF-cables
 Processor card

Notes: 1. Exceeding absolute maximum ratings may cause permanent damage.
 2. Pulsed, 2.5 % duty cycle of 4620 μs period, 50 Ω. Operation between operating maximum and absolute maximum for extended periods may reduce reliability.

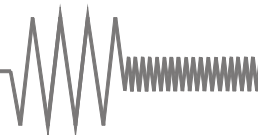

Programmable Delay Line DL1-544-1600ps

MTS-No.: 28150

Typical measurements:

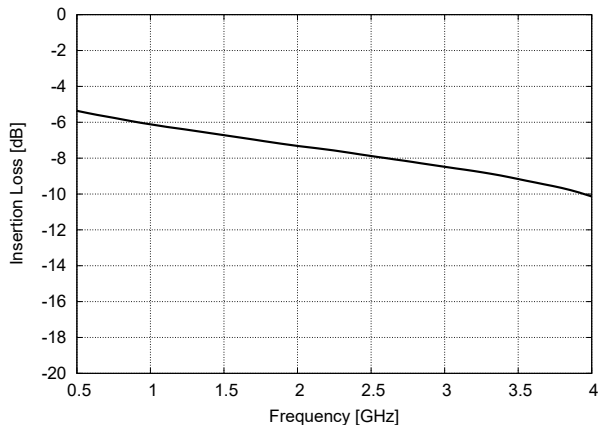

Fig. 1: Input to output port insertion loss @ 0 ps

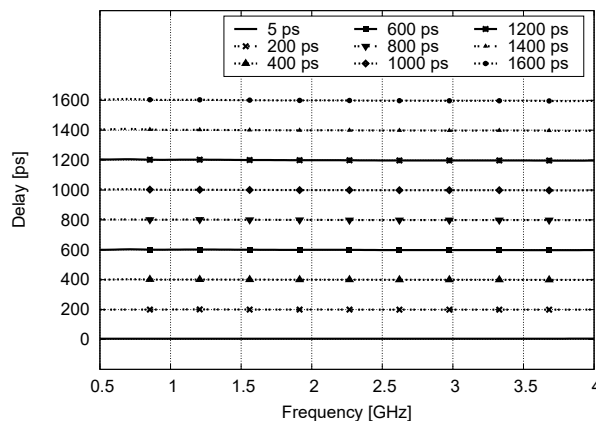

Fig. 2: Delay relative to insertion loss

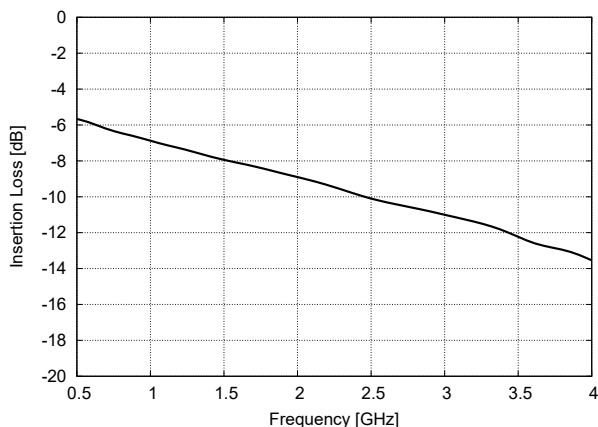

Fig. 3: Input to output port insertion loss @ 1600 ps

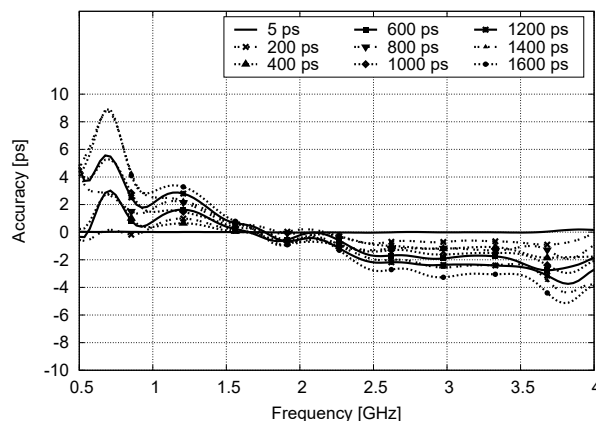

Fig. 4: Delay accuracy

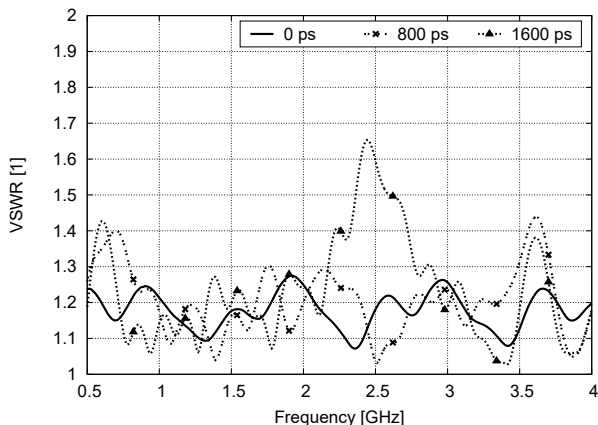
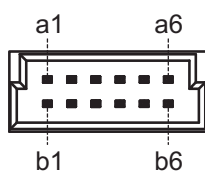
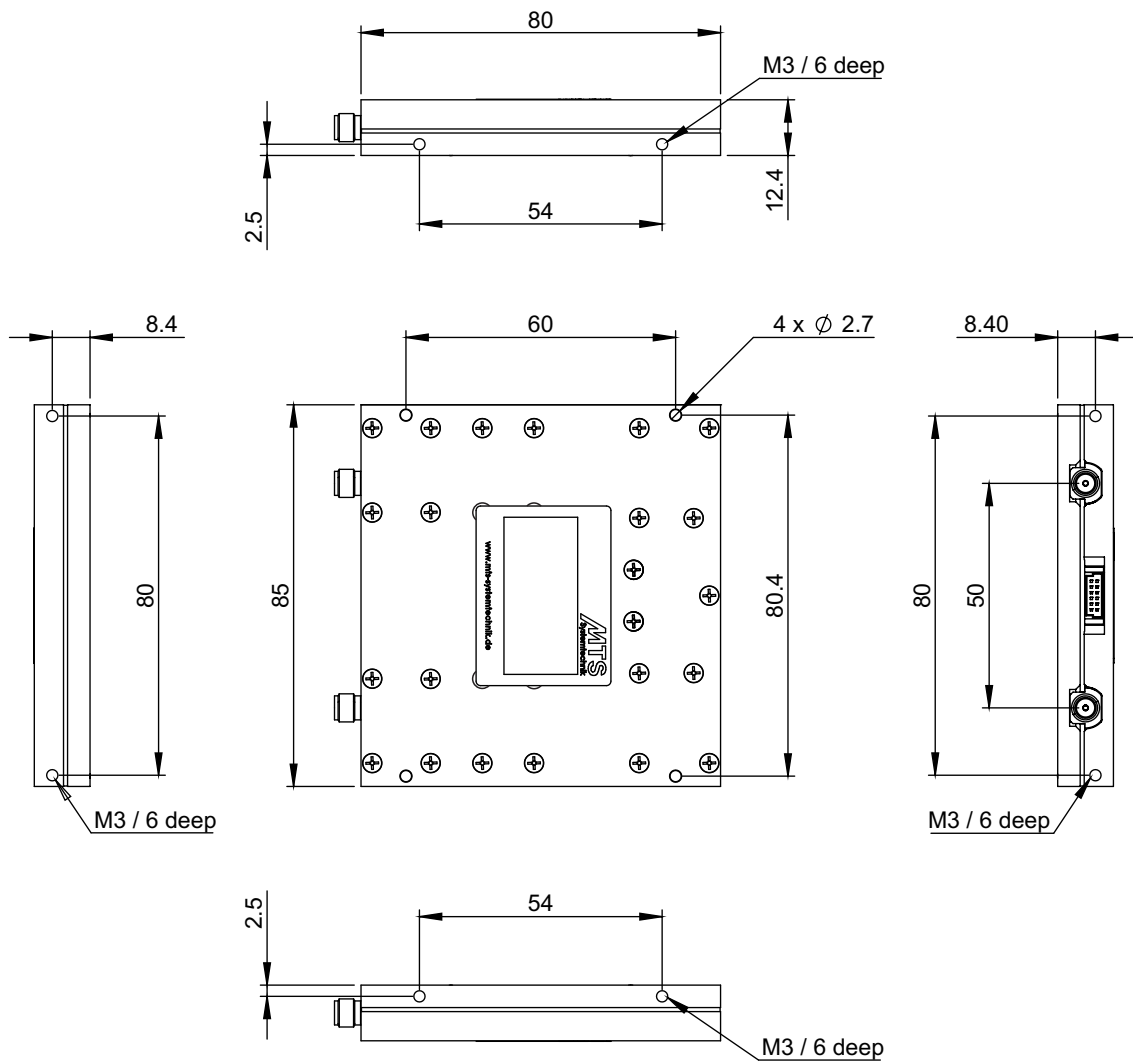

Fig. 5: VSWR for input and output ports

Programmable Delay Line DL1-544-1600ps

MTS-No.: 28150

Views:



Pin assignment			
Pin	Grade	Pin	Grade
a1	D0 (10 ps)	b1	D1 (20 ps)
a2	D2 (40 ps)	b2	D3 (80 ps)
a3	D4 (160 ps)	b3	D5 (320 ps)
a4	D6 (640 ps)	b4	D7 (5 / 330 ps)
a5	+5V	b5	+5V
a6	GND	b6	GND